

**Grade : NC45**

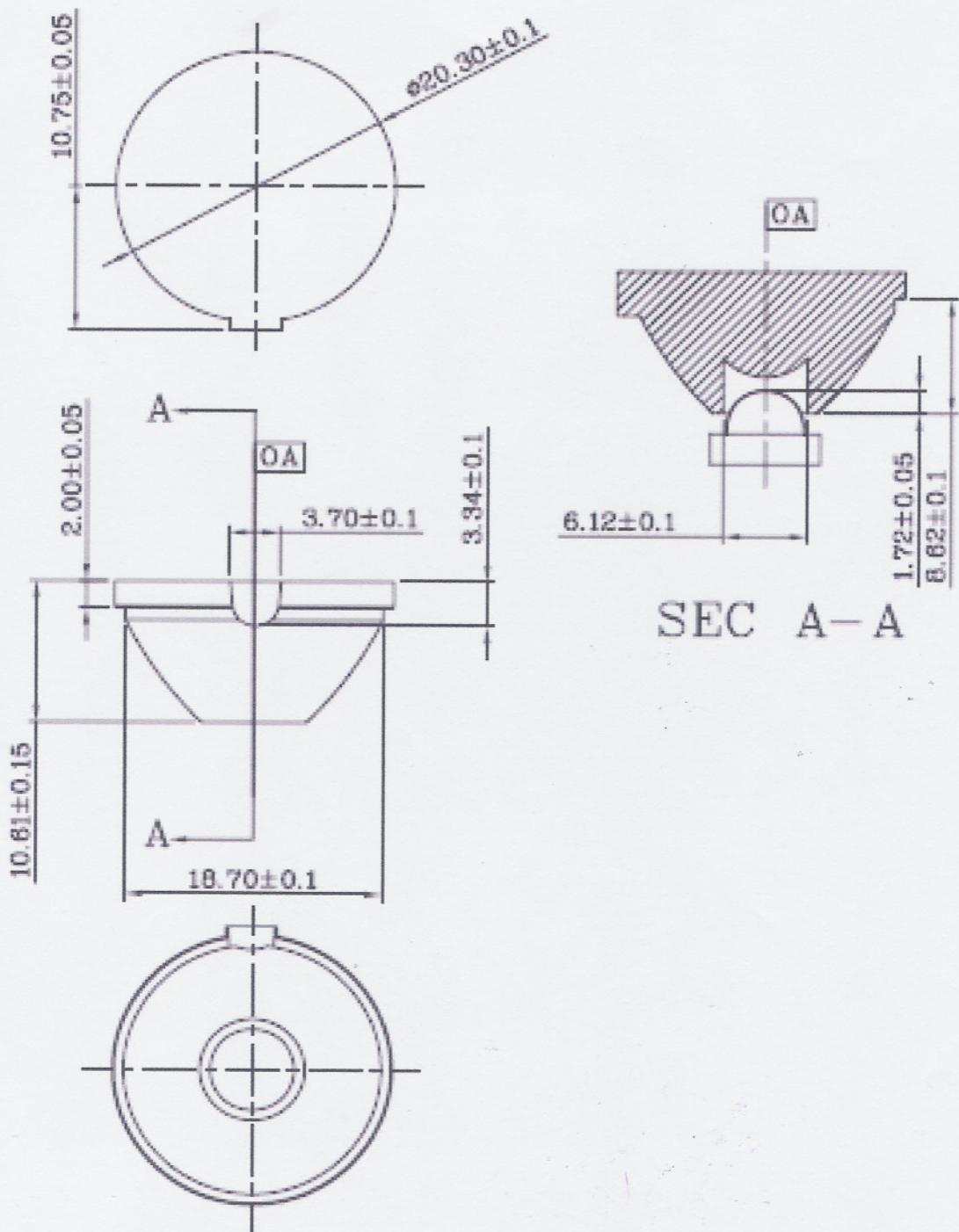

**DONGHWA IND CO., LTD.**

# Grade : HOLDER\_N\_8mm

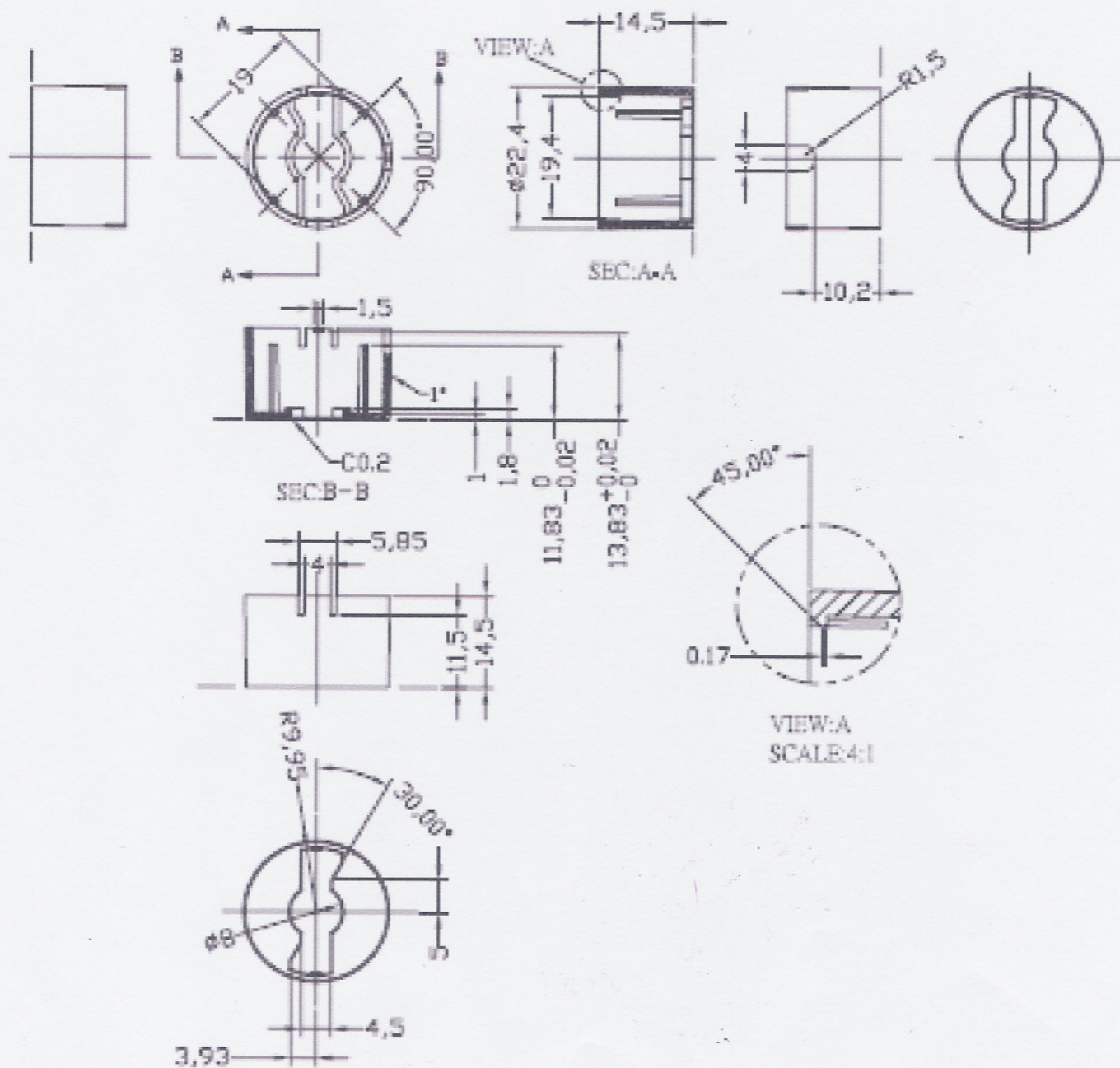

**DONGHWA IND CO., LTD.**